

Fig. 1

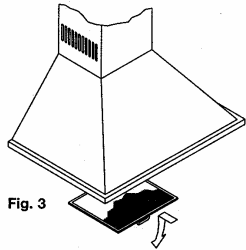

Fig. 3

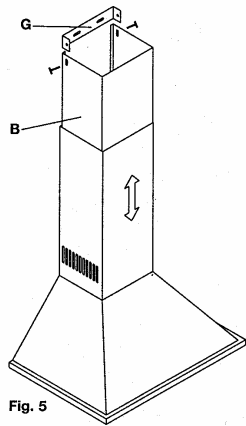

Fig. 5

BETA - 600  
 BETA - 700  
 BETA - 900  
 OMEGA - 600  
 OMEGA - 900

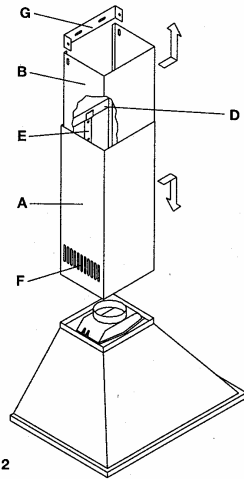

Fig. 2

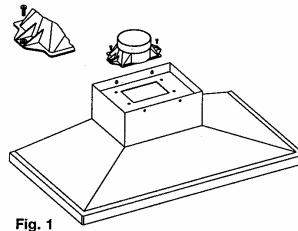

Fig. 1

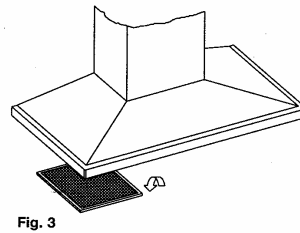

Fig. 3

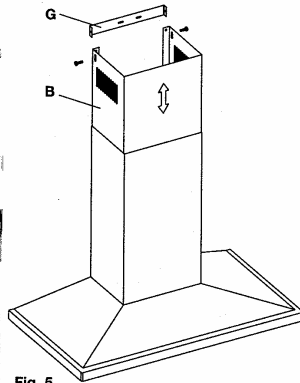

Fig. 5

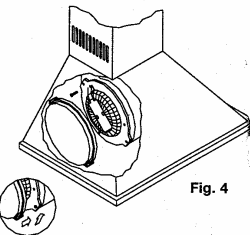

Fig. 4

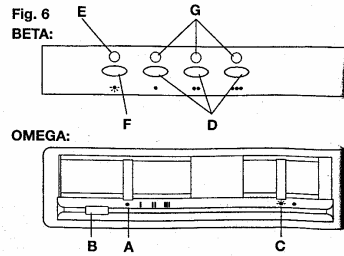

Fig. 6  
 BETA:

OMEGA:

V PLUS - 900  
 BETA - 1200

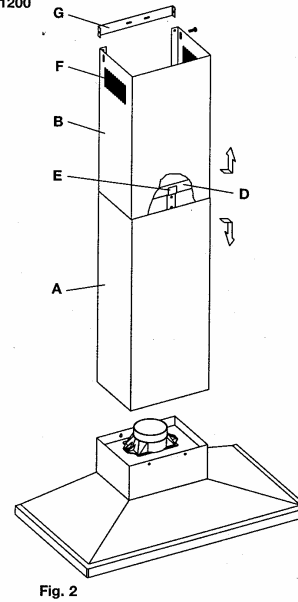

Fig. 2

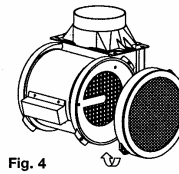

Fig. 4

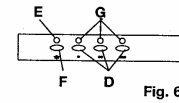

Fig. 6

## DECORATIVE EXTRACTOR HOODS

Dear client:

We are sure that the purchase of our extractor hood will fully satisfy all of your needs. Please read this instruction manual carefully in order to obtain the best results from the use of the hood.

### IMPORTANT

For our guarantee to be effective, you must present your purchase receipt along with the guarantee certificate. Otherwise, the guarantee will have no effect.

### INSTRUCTIONS FOR INSTALLATION, MAINTENANCE AND USE

#### GENERAL INDICATIONS

Before installing and using the hood, be sure that the voltage (V) and the frequency (Hz) indicated on the feature plate match the voltage and frequency at the installation site.

The feature plate and technical data are shown on the inside of the product.

This hood is equipped with an extendible tube which allows it to be adjusted to the height of the stove.

#### TECHNICAL CHARACTERISTICS

**Voltage and Frequency: 220-230 V ~ 50 Hz / 220 V ~ 60 Hz.**

Total power: 320 W

Three speed motor: 240 W

Lights: 2 x 40 W

**Voltage and Frequency: 110 V ~ 60 Hz.**

Total power: 390 W

Three speed motor: 290 W

Lights: 2 x 50 W

**Voltage and Frequency: 127 V ~ 60 Hz.**

Total power: 380 W

Three speed motor: 280 W

Lights: 2 x 50 W

#### INSTALLATION

The hood can be installed to work in two different ways: If there is a possibility of installing the hood with an exhaust pipe to the outside, it will be used in Suction mode. If this possibility does not exist, the hood will be used in Filtering mode whereby air is recirculated by active carbon filters.

#### Suction

If the hood is to be installed as a SUCTION hood, connect the plastic conical outlet piece supplied with the hood (125 mm diameter) to an exhaust pipe connected directly to the

outside. (Fig. 1).

We recommend the use of the 125 mm diameter pipe for better performance and lower noise levels.

#### Filter

This hood can be transformed into an air purifier if there is no possibility of connecting it to the outside.

In this case, air is circulated through opening F (Figure 2). In order for the hood to function as a filtering purifier, two active carbon filters, supplied as separate accessories, must be used. The active carbon filters must be replaced periodically to work properly, at least once every three months (depending on the frequency with which the hood is used). (Fig. 4).

**NOTE:** Do not connect the hood to chimneys, ventilation pipes or hot air pipes. Before connecting any pipes, consult municipal ordinances on exhaust air and request permission from the person in charge of the building. Be sure there is adequate ventilation, even in cases where the hood is to be used simultaneously with another product.

#### Wall mounting

- The accessories needed to install the hood are inside the hood.

- The hood must be installed at a minimum distance of 66 cm from the stovetop.

- Place the attached jig in the location where the hood is to be mounted and attach with adhesive tape.

- Drill holes in the wall using a 6 mm drill bit.

- The plugs and screws needed to hang the hood are contained in the bag of accessories supplied with the hood.

#### Electrical connection

Connect the cord to a socket or omnipolar switch which must have a minimum contact opening distance of 3 mm.

*The manufacture shall not be liable in the event that all safety regulations in force for the correct and normal operation of electrical parts are not observed.*

*This hood complies with European Directives EG No. 76/889 EEC and 82/499 EG on protection against radial interference.*

#### Assembly of Decorative Extendible Tube

- Mark the wall at the location of support E (Figure 2) according to the heights and specifications shown on the attached jig.

- Drill holes in the wall, place plugs in the holes and attach support E with screws.

- Place tube A (Figure 2) with the extendible part B hanging on the inside, making sure that billet D (Figure 2) is

correctly attached to support E (Figure 2).

- Next, secure support G to the upper end of the wall, making sure that it is properly aligned with the extendible tube. Extend the movable part of tube B until it reaches support G and connect to the support with the two side screws. (Fig. 5).

#### CONTROL PANEL (BETA - V PLUS)

This panel is located on the front of the hood and includes:

- 3 position switch controls the motor (1st, 2nd, and 3rd speed) (Figure 6, Ref. D).

- Lighting control lamp. Fig. 6. Ref. E.

- Motor controls lamps. Fig. 6, Ref. G.

- Light switch (Figure 6, Ref. F).

#### TIMING

To operate the canopy timer, having selected the speed, press the button for 2 seconds until the luminous led blinks. The timer will then work for 15 minutes.

At the end of this time the motor will stop and the light will go out. If it is still on, and you wish to cancel the timing, press the timer button once and the motor will stop.

#### CONTROL PANEL (OMEGA)

This panel is located on the lower part of the hood and includes:

- 4 position motor control switch (OFF, 1st, 2nd, and 3rd speed positions) (Figure 6, Ref. A).

- Control light for motor operation (Figure 6, Ref. B).

- Light switch (Figure 6, Ref. C).

#### MAINTENANCE

- Cleaning

Before any type of operation, always make sure that the electrical cord is disconnected and the switch is in the off position.

Clean the external part with a mild, liquid detergent and avoid the use of abrasive cleaning products.

- Changing the light

Before changing the light make sure that the hood is not connected.

Remove the grease filter (Figure 3) and replace the light with an oval light bulb of no more than 40 W.

Place the filter in position.

#### IMPORTANT WARNING FOR EXTRACTOR HOODS WITH HALOGEN LAMPS

If the halogen lamps have to be replaced, they must be replaced by lamps with an aluminium reflector, never dichroic lamps, to avoid unnecessary overheating in the lamp holders.

- Cleaning the grease filter.

Depending on use, and at least once a month, the grease filters should be disassembled (Figure 3) and cleaned in a

dishwasher or with hot soapy water.

If washed in a dishwasher they should be placed in an upright position to prevent food remains from falling on them.

After rinsing and drying, replace the filters by following the steps for disassembly in reverse order.

#### IMPORTANT

Never leave frying food unattended since grease can overheat and catch fire. The risk of fire is even greater in the case of used oil.

Never use the hood in areas where devices with exhaust pipes connected to the outside are already operating unless perfect ventilation can be guaranteed.

To avoid the possibility of fire, adhere strictly to all of the recommendations included here and to the periodic cleaning of the grease filters.

THE MANUFACTURER DECLINES ALL LIABILITY IN CASES WHERE THE INSTRUCTIONS FOR THE APPROPRIATE INSTALLATION, MAINTENANCE AND USE OF THE EXTRACTOR HOOD ARE NOT OBSERVED.

When the power supply cord is damaged it must be replaced by an official dealer.

Should the rangehood ever require service, contact Parex Industries Ltd.:  
Australia: 1800 126 659  
New Zealand: 09 915 7273