

# DE'LONGHI

## COOKING

---

**INSTALLATION and SERVICE INSTRUCTIONS  
USE and CARE INSTRUCTIONS**

**SLI 905  
CERAMIC INDUCTION COOKTOP**

distributed by  
**ELBA Appliances Australia**  
(a Division of Fisher&Paykel Australia)





## **Dear Customer,**

*Thank you for having purchased and given your preference to our product.*

*The safety precautions and recommendations reported below are for your own safety and that of others. They will also provide a means by which to make full use of the features offered by your appliance.*

*Please keep this booklet in a safe place. It may be useful in future, either to yourself or to others in the event that doubts should arise relating to its operation.*

***This appliance must be used only for the task it has explicitly been designed for, that is for cooking foodstuffs. Any other form of usage is to be considered as inappropriate and therefore dangerous.***

***The manufacturer declines all responsibility in the event of damage caused by improper, incorrect or illogical use of the appliance or by faulty installation.***

This appliance has been designed and constructed in accordance with the following codes and specifications:

AS/NZS 60335.1      General Requirements for Domestic electrical appliances

AS/NSZ 60335.2.6      Particular Requirements for Domestic electrical cooking appliances

AS/NZS CISPR 14.1      Electromagnetic Compatibility Requirements

### **PRODUCT LABEL**

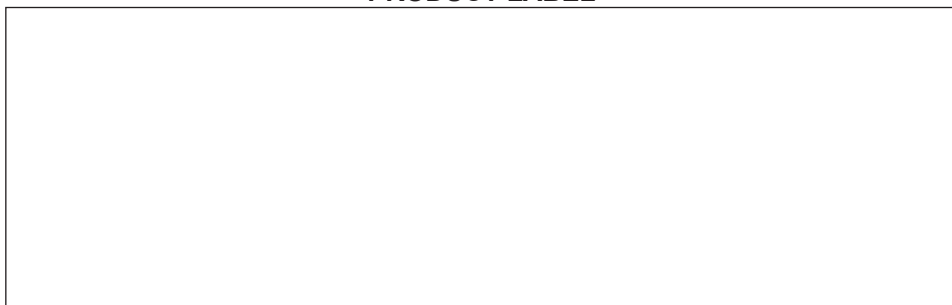

## IMPORTANT SAFETY PRECAUTIONS AND RECOMMENDATIONS

**IMPORTANT: This appliance is designed and manufactured solely for the cooking of domestic (household) food and is not suitable for any non domestic application and therefore should not be used in a commercial environment.**

**The appliance guarantee will be void if the appliance is used within a non domestic environment i.e. a semi commercial, commercial or communal environment.**

**Read the instructions carefully before installing and using the appliance.**

- This appliance has been designed and manufactured in compliance with the applicable standards for the household cooking products, including those for surface temperatures. Some people with sensitive skin may have a more pronounced temperature perception with some components although these parts are within the limits allowed by the norms. The complete safety of the appliance also depends on the correct use, we therefore recommend to always pay a extreme attention while using the product, especially in the presence of children.
- After having unpacked the appliance, check to ensure that it is not damaged. In case of doubt, do not use it and consult your supplier or a professionally qualified technician.
- Packing elements (i.e. plastic bags, polystyrene foam, nails, packing straps, etc.) should not be left around within easy reach of children, as these may cause serious injuries.
- Some appliances are supplied with a protective film on steel and aluminium parts. **This film must be removed before using the appliance.**
- **IMPORTANT:** The use of suitable protective clothing/gloves is recommended when handling or cleaning this appliance.

- Do not attempt to modify the technical characteristics of the appliance as this may become dangerous to use. The manufacturer declines all responsibility for any inconvenience resulting from the inobservance of this condition.
- Do not operate your appliance by means of an external timer or separate remote-control system.
- Do not carry out cleaning or maintenance operations on the appliance without having previously disconnected it from the electric power supply.
- Do not use a steam cleaner because the moisture can get into the appliance therefore making it unsafe.
- Do not cover the hob with aluminium foils.
- Do not touch the appliance with wet or damp hands (or feet).
- Do not use the appliance whilst in bare feet.
- If you should decide not to use this appliance any longer (or decide to substitute another model), before disposing of it, it is recommended that it be made inoperative in an appropriate manner in accordance to health and environmental protection regulations, ensuring in particular that all potentially hazardous parts be made harmless, especially in relation to children who could play with unused appliances.
- The various components of the appliance are recyclable. Dispose of them in accordance with the regulations in force in your country. If the appliance is to be scrapped, remove the power cord.
- After use, ensure that the controls are in the off position.
- Children less than 8 years of age shall be kept away unless continuously supervised.
- This appliance can be used by children aged from 8 years and above and persons with reduced physical, sensory or mental capabilities or lack of experience and knowledge if they have been given supervision or instruction concerning use of the appliance in a safe way and understand the hazards involved. Children shall not play with the appliance. Cleaning and user maintenance shall not be made by children without supervision.

- The manufacturer declines all liability for injury to persons or damage to property caused by incorrect or improper use of the appliance.
- **WARNING:** During use the appliance and its accessible parts become hot; they remain hot for some time after use.
  - Care should be taken to avoid touching heating elements on the hob.
  - To avoid burns and scalds, young children should be kept away.
- Make sure that electrical cables connecting other appliances in the proximity of the cooktop cannot come into contact with the hob.
- **WARNING:** Unattended cooking on a hob with fat or oil can be dangerous and may result in fire. **NEVER** try to extinguish a fire with water, but switch off the appliance and then cover flame e.g. with a lid or a fire blanket.
- **WARNING:** Danger of fire: do not store items on the cooking surfaces.
- Do not place or leave empty pans on the glass ceramic hob.
- Do not allow heavy or sharp objects to drop on the glass ceramic hob.
- Do not scratch the hob with sharp objects. Don't use the hob as a work surface.
- **WARNING:** If the hob is cracked or otherwise damaged by falling objects etc., disconnect the appliance from the electrical power supply to avoid the possibility of electric shock and call Customer Service.
- **WARNING:** When correctly installed, your product meets all safety requirements laid down for this type of product category. However special care should be taken around the underneath of the appliance as this area is not designed or intended to be touched and may contain sharp or rough edges, that may cause injury.
- **CAUTION:** The cooking process has to be supervised. A short term cooking process has to be supervised continuously.

- Models provided with power supply cable. If the power supply cable is damaged, it must be replaced only by an authorised service agent in order to avoid a hazard.
- If the appliance is not fitted with a supply cord and a plug, or with other means for disconnection from the supply mains having a contact separation in all poles that provide full disconnection under overvoltage category III conditions, means for disconnection must be incorporated in the fixed wiring in accordance with the wiring rules.
- **WARNING:** The appliance and its accessible parts become hot during use.  
Care should be taken to avoid touching heating elements.  
Children less than 8 years of age shall be kept away unless continuously supervised.
- **WARNING:** Use only hob guards designed by the manufacturer of the cooking appliance or indicated by the manufacturer of the appliance in the instructions for use as suitable or hob guards incorporated in the appliance. The use of inappropriate guards can cause accidents.
- Do NOT place combustible materials or products on this appliance at any time.
- Do NOT spray aerosols in the vicinity of this appliance while it is in use.
- **IMPORTANT NOTE:** This appliance shall not be used as a space heater, especially if installed in marine craft or caravans.
- **INDUCTION HOBBS:**
  - Metallic objects such as knives, forks, spoons and lids should not be placed on the hob surface since they can get hot.
  - Do not use metallic kitchen utensils (e.g. ladles). It is preferable to use plastic or wood kitchen utensils.
  - Please use pans of recommended size (see minimum pan diameter recommended). It is not advisable to use pans smaller than the cooking zone. The pans have to be placed in the centre of the cooking zone.
  - Do not use defective pans or pans with a curved bottom.

- Please use suitable pans marked for induction cooking.
- Please keep your distance from the electromagnetic fields by standing 5-10 cm from the cooking zones. When possible use the rear cooking zones.
- Magnetic objects (e.g. credit cards, floppy disks, memory cards) and electronic instruments (e.g. computers) should not be placed near the induction hob.
- The heating of magnetic tins is forbidden! Closed tins may explode by exceeding pressure while heating. There is a burning risk with open tins as well, because the integrated temperature protection will not work correctly.
- **IMPORTANT WARNING:** The induction hob complies with the local applicable Standards for domestic cooking appliances. Therefore it should not interfere with other electronic units. Persons with cardiac pacemakers or any other electrical implants must check with their doctor if they can use an induction cooking system (and check any possible interferences with the implants).



# **Advice for the installer**

# 1

## INSTALLATION

### IMPORTANT:

- The appliance is designed and approved for domestic use only and should not be installed in a commercial, semi commercial or communal environment.  
**Your product will not be guaranteed if installed in any of the above environments and could affect any third party or public liability insurances you may have.**
- This appliance is to be installed only by an authorised person according to the current local regulations and in observation of the manufacturer's instructions. Failure to comply with this condition will render the guarantee invalid.
- Incorrect installation, for which the manufacturer accepts no responsibility, may cause personal injury or damage.
- This appliance shall only be serviced by authorized personnel.
- Always disconnect the cooktop from mains power supply before carrying out any maintenance operations or repairs.
- **Important: The use of suitable protective clothing/gloves is recommended when handling or installing this appliance.**
- **The appliance must be housed in heat resistant units.**
- **The walls of the units must not be higher than work top and must be capable of resisting temperatures of 70 °C above room temperature.**
- **We would point out that the adhesive which bonds the plastic laminate to the furniture must withstand temperatures not less than 150 °C to avoid delamination.**
- **Standard installation (not flush): Do not seal the cooktop into the benchtop with silicone or glue; this makes future servicing difficult. Elba Appl. AUS Service Agent will not cover the costs of removing the cooktop, or of damage caused by this removal.**
- **Do not install the appliance near inflammable materials (eg. curtains).**

### WARNING

When correctly installed, your product meets all safety requirements laid down for this type of product category.

However special care should be taken around the underneath of the appliance as this area is not designed or intended to be touched and may contain sharp or rough edges, that may cause injury.

## STANDARD INSTALLATION

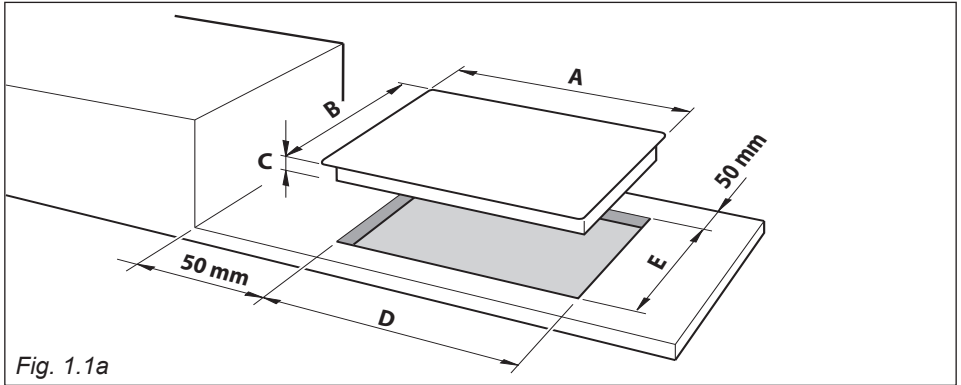

## FLUSH INSTALLATION (MODELS WITHOUT METAL TRIM/S ONLY)

If you wish to install the hob flush with the work surface, it is necessary to execute/carry out a milling in the hole of the cut-out as indicated in fig. 1.1b.

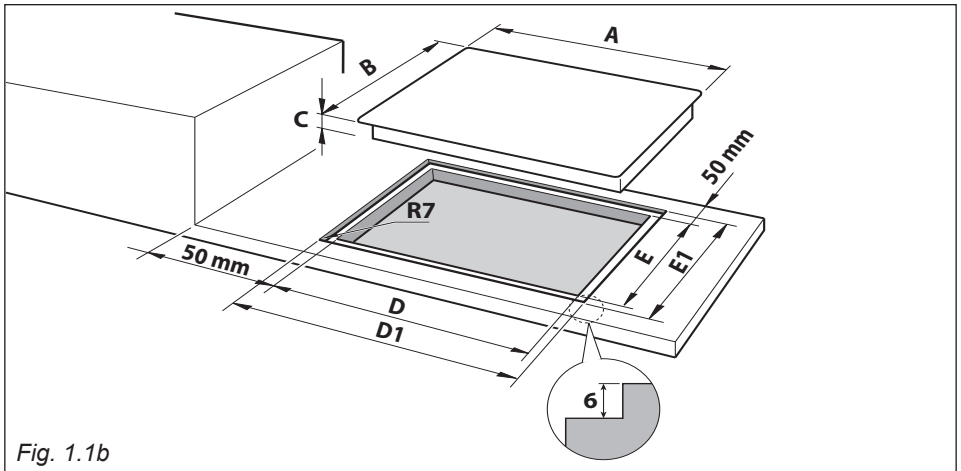

Description	Measures (mm)						
	A (*)	B (*)	C (**)	D	D1	E	E1
<b>90cm wide models</b>	900	520	47 or 53 for flush installation	840	905	480	525

(\*) For models with metal trim/s add 4mm to the measurement for each trim.  
Example: front metal trim= B+4mm.

(\*\*) from the top of countertop to bottom of cooktop.

## FITTING REQUIREMENTS

This cooktop can be built into a working surface from 20 mm thick and 600 mm deep.

In order to install the ceramic hob into the kitchen fixture, a hole with the dimensions shown in figures 1.1a or 1.1b has to be made, keeping in consideration the following:

- The cooktop shall not be installed directly above a dishwasher, fridge, freezer, washing machine or clothes dryer, as the humidity may damage the cooktop electronics.
- If the cooktop is installed above an oven, the oven shall be provided with cooling fan. The two appliances should be connected to the electrical supply with independent connections.
- **IMPORTANT WARNING! This cooktop requires adequate supply of fresh, cool air to fully function. The base of the cooktop must have direct unrestricted ventilation to the room where the cooktop is installed. Follow the requirements of figure 1.3 or 1.4.**
- There must be a distance of at least 650 mm between the hob and any wall cupboard or extractor hood positioned immediately above (see fig. 1.2).
- Standard installation (not flush): Do not seal the cooktop into the benchtop with silicone or glue; this makes future servicing difficult. Elba Appl. AUS Service Agent will not cover the costs of removing the cooktop, or of damage caused by this removal.
- **The walls surrounding the cooktop must be made of heat-resistant material.**
- **Do not install the appliance near inflammable materials (eg. curtains).**

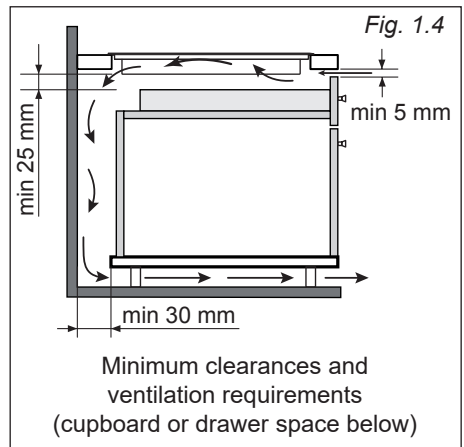
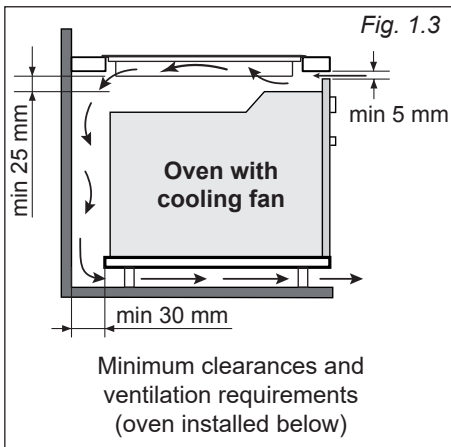
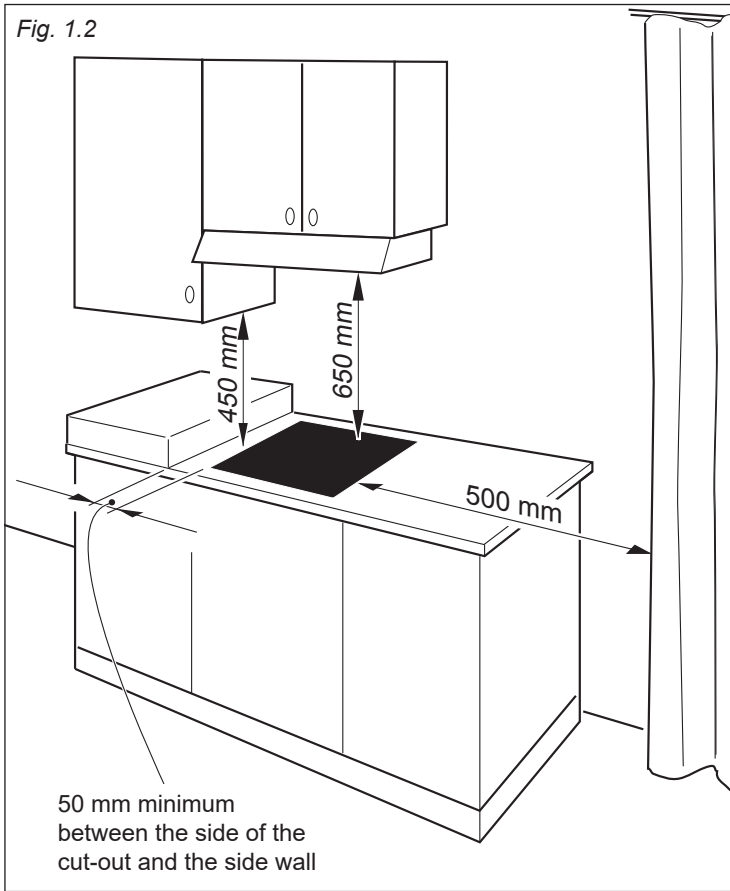

## FASTENING THE COOKTOP

Each cooktop is provided with an installation kit including brackets and screws for fastening the cooktop to benches from 20 mm thick. Before you install the cooktop, make sure that the work surface is square and level, and no structural members interfere with space requirements previously indicated.

The kit includes four metal clips “B” and four self-threading screws “A” (fig. 1.5).

- Cut the unit according to the dimensions in fig. 1.1a or 1.1b.
- Turn the hob upside down and rest the glass side on a soft surface.
- Spread the seal “D” around the edge of the hob (fig. 1.6).
- Fasten the metal clips “B” into the hole “C” using the screws “A”. Make sure that the metal clips are mounted correctly as shown in the figure 1.5. The metal clips have to be fitted on front and back (not sides).
- Put the cooktop into the cutout and position it correctly.
- Using a sharp cutter or trimmer knife, trim the excess sealing material around the edge of the cooktop. Take care not to damage the workbench.
- In case to install the hob flush with the work surface, fill any gaps between the glass and along the perimeter of the work surface with insulating silicone, and wipe away any excess.

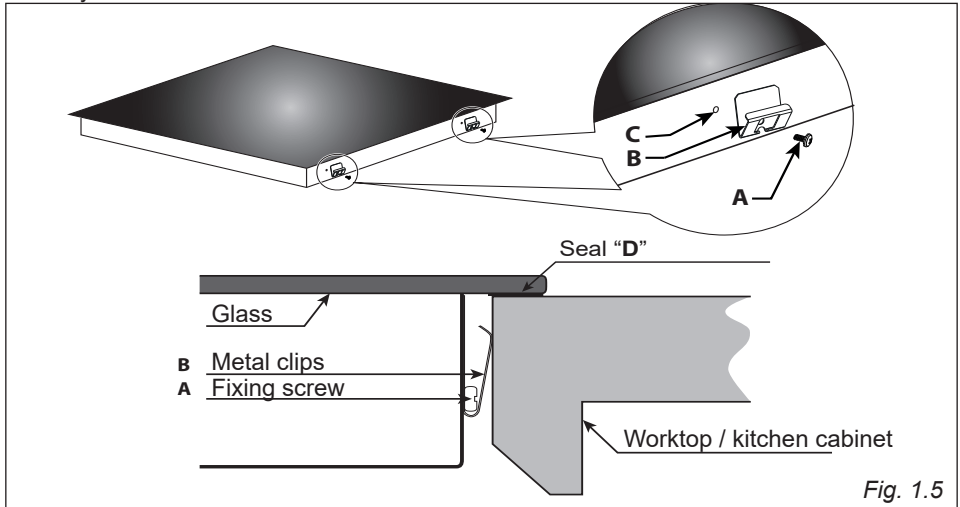

**IMPORTANT:** Spread the sealing material “D” around the edge of the hob (edge of the glass). The sealing material “D” must be installed correctly to guarantee a perfect seal between the appliance and the unit. Incorrect installation may cause irreparable damage to the appliance.

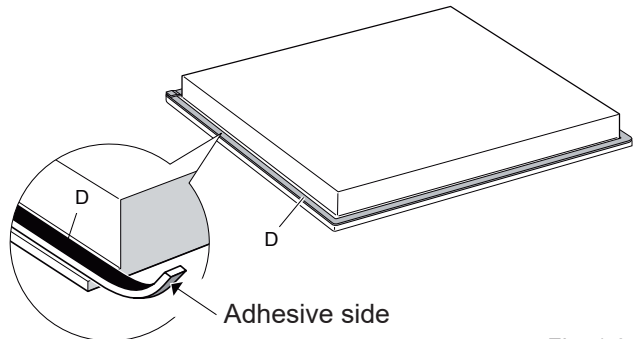

# 2

## ELECTRICAL SECTION

**IMPORTANT:** Installation must be carried out according to the manufacturer's instructions. Incorrect installation may cause harm and damage to people, animals or property, for which the manufacturer accepts no responsibility.

Before carrying out any work on the electrical section of the appliance, it must be disconnected from the mains.

**Connection to a good earth wiring system is absolutely essential.**

The manufacturer accepts no responsibility for any inconvenience caused by failure to comply with this rule.

If the hob surface is cracked disconnect the appliance from the mains and contact the After-Sales Service.

### ELECTRICAL REQUIREMENTS

- Connection to the electric power supply must be carried out by a qualified technician and following the appropriate safety regulations.
- The appliance must be connected to the mains checking that the voltage corresponds to the value given in the rating plate and that the electrical cable sections can withstand the load specified on the plate.
- The appliance should be connected directly to the mains placing an omnipolar switch with minimum opening between the contacts of 3 mm between the appliance and the mains (Australia and New Zealand only: means providing full disconnection under overvoltage category III conditions must be incorporated in the fixed wiring in accordance with AS/NZS 3000).
- The power supply cable must not touch the hot parts and must be positioned so that it does not exceed 50°C above ambient.
- Once the appliance has been installed, the switch must always be in a accessible position.

**N.B. For connections to the mains power supply, never use adaptors, reductions or multiple power points as these may overheat and catch fire.**

In the event that installation should require modifications to the mains supply wiring system, it is recommended that a qualified technician be called to carry out substitution. He should also check that the domestic electrical system is suitable for the power absorbed by the appliance.

### VOLTAGE AND POWER CONSUMPTION

220-240/380-415 V 3N    50-60 Hz    10400 W (45.21 A) (diversity cannot be applied)

## MODELS SUPPLIED WITH POWER CORD ALREADY FITTED TO THE APPLIANCE

- Connection to the electric power supply must be carried out by a qualified technician according to the local regulations in force.
- **If the supply cord is damaged, it must be replaced by the manufacturer or its service agent or a similarly qualified person in order to avoid a hazard.**

## MODELS SUPPLIED WITHOUT POWER CORD ALREADY FITTED TO THE APPLIANCE

- Connection to the electric power supply must be carried out by a qualified technician according to the local regulations in force.
- Fit a suitable power cord, according to the power rating of the appliance, type:
  - H05RR-F, H07RN-F;
  - or H05VV-F, H05V2V2-F (resistant to temperatures of 90°C)”.

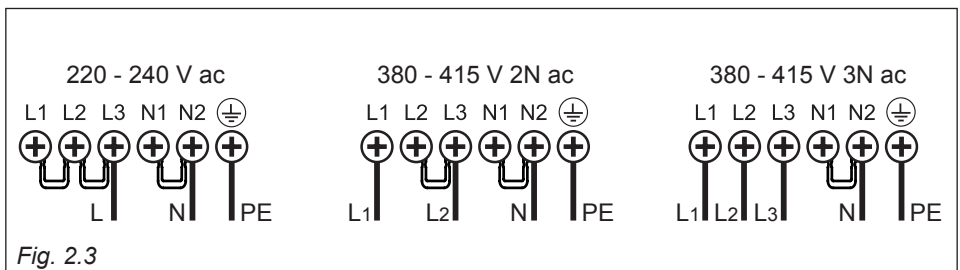
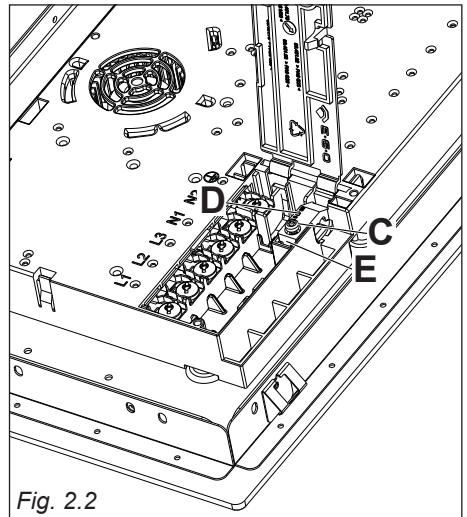
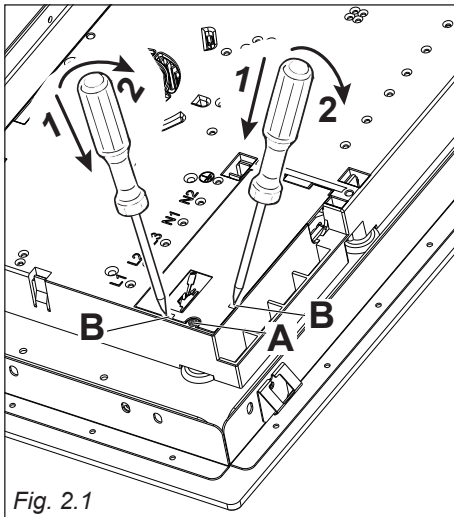



**ATTENTION!**

All the operations/electrical connections must be carried out by a qualified technician.

**CAUTION!**

Do not pierce or weld the terminal ends of the wires. This is strictly forbidden!

**CAUTION!**

Do not connect the power cord to the electrical power supply without the metallic terminals correctly in place.

**If the supply cord is damaged, it must be replaced by the manufacturer or its service agent or a similarly qualified person in order to avoid a hazard.**

**ELECTRIC DIAGRAM**

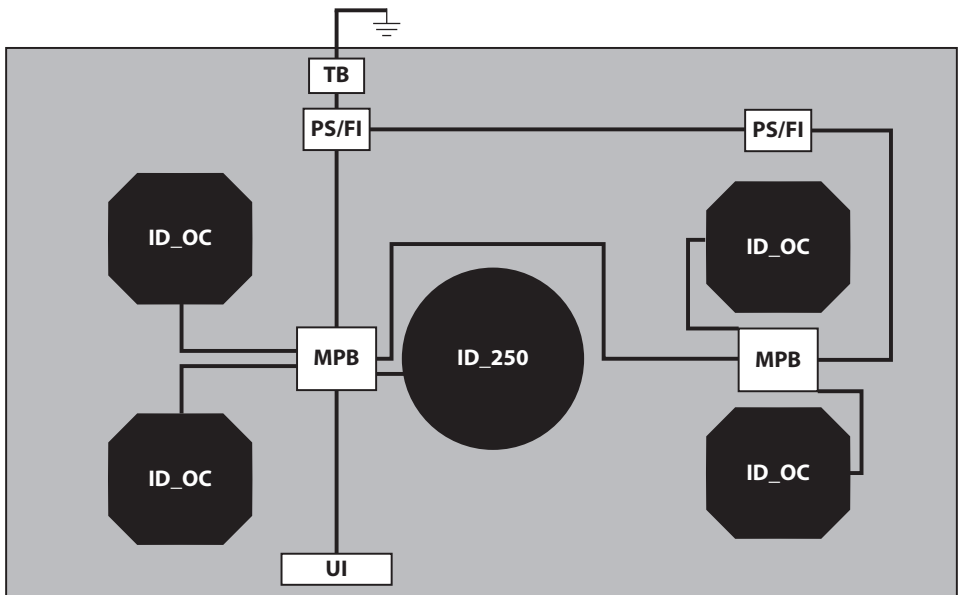

**ELECTRIC DIAGRAM KEY**

- MPB** Main power board
- PS/FI** Power supply/Filter
- UI** User interface
- ID\_250** Induction zone Ø250mm
- ID\_OC** Induction 'Octa' zone 160x180mm
- TB** Terminal block



# User guide

# 1

## FEATURES AND TECHNICAL DATA

Fig. 1.1

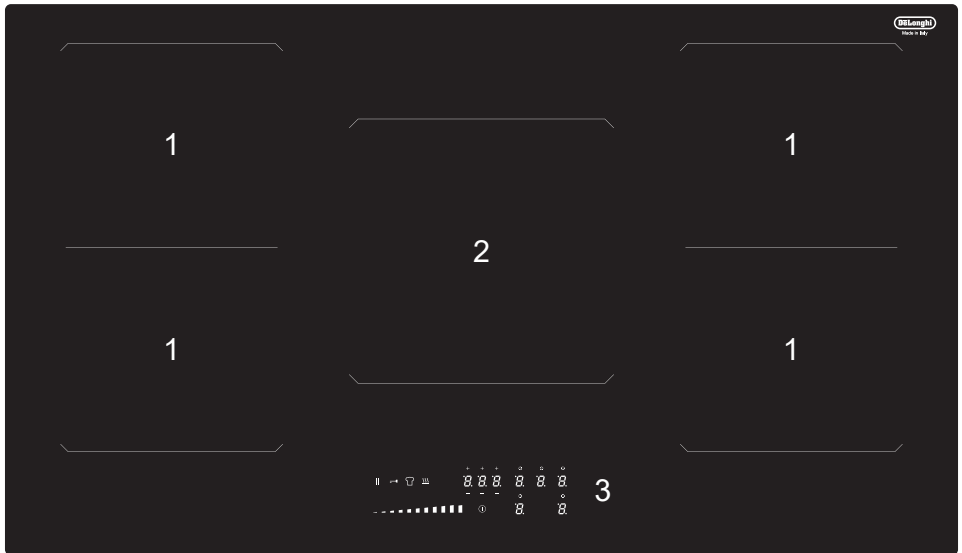

1. Induction cooking zone	190 x 210 mm	Normal Power: 2100 W Booster Power: 2300 W Double Booster: 3000 W “Bridge” function: when enabled, the cooking zones work together as a single zone - 3700 W.
2. Induction cooking zone	Ø 250 mm	Normal Power: 2300 W Booster Power: 3000 W
3. Touch controls		

Note: The Nominal and Booster Power may change depending on the size and material of the pan set on the cooking zone.

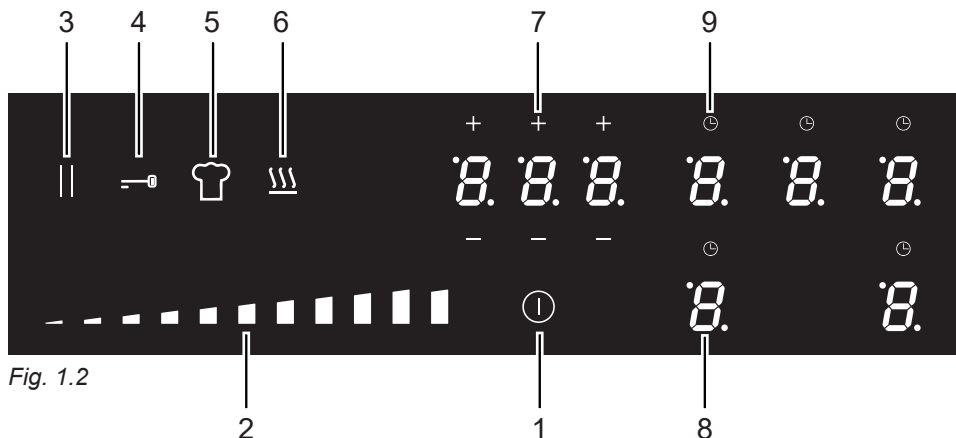

Fig. 1.2

## TOUCH CONTROLS

1. ON/OFF key
2. Setting selector
3. Pause function key
4. Child lock selection key
5. Chef cook function key
6. Warming function key
7. Automatic cooking (timer) display and keys
8. Selection zone key (one for each zone)
9. Timer key (one for each zone)

### Notes:

- Each selection (by touching one of the keys) is indicated by an acoustic signal (beep).
- The touch control area is switched off automatically (and a warning beep sounds for 10 seconds):
  - if one or more keys are touched for more than 10 seconds;
  - if an object is positioned on the touch control area;
  - in the case of spillage of liquids on the control keys.

**Attention: Detach the appliance from the mains if the ceramic glass is cracked and contact the After-Sales Service.**

**Metallic objects such as knives, forks, spoons and lids should not be placed on the hob surface since they can get hot.**

## 2 USE OF INDUCTION HOB

The ceramic hob is fitted with induction cooking zones.

These zones, shown by painted disks on the ceramic surface, are controlled by a touch control system.

In the front central area of the hob, the displays of the touch control system indicate:



= Cooking zone Off (not activated)



= Cooking zone On (activated but not operating).

If all the zones are in zero setting, the touch control system switches off automatically (touch controls Off) after about 20 seconds.



= Power levels



= GentleHeat low setting



= "Fast heating" function



= "Bridge" function



= "Booster" function



= Double "Booster" function (available for some zones only)



= Remaining heat indicator



= Pan detection indicator



= Pause function

Note: Each lit figure refers to the relevant cooking zone.

### INDUCTION COOKING SYSTEM

When your induction hob is switched On and a cooking zone has been selected, the electronic circuits produce induced currents that instantaneously heat the bottom of the pan which then transfers this heat to the food. Cooking takes place with hardly any energy loss between the induction hob and the food.

Your induction hob operates only if a correct pan with the right features is placed on a cooking zone. Please refer to "COOKWARE/COFFEE POT FOR INDUCTION COOKING".

If the pan detection symbol  appears on the display, your pan is not suitable and your induction hob will not operate. After 10 minutes without detecting any pan, the cooking zone switches Off automatically.

If the induction cooktop emits a humming noise when a zone is used on a high power level, this phenomenon is normal as it is caused by the induction cooking technology.

The noise should weaken or disappear completely when the power level is decreased.

## REMAINING HEAT INDICATORS

When the temperature of a cooking zone is still hot, the relevant  remaining heat indicator lights up on the display to alert you of the hot surface.

Avoid touching the hob surface over the cooking area. Please pay special attention to children.

When the  is lit on the display, it is still possible to start cooking again; just operate the cooking zone as indicated in the chapter POWER IGNITION AND ADJUSTMENT OF A COOKING ZONE.

## COOKWARE/COFFEE POT FOR INDUCTION COOKING

The induction cooking system OPERATES ONLY if using correct cookware suitable for induction cooking (normally identified by an induction symbol on the bottom of the cookware/ coffee pot). The use of not suitable cookware may cause damage to the appliance.

The bottom of the pan/coffee pot has to be ferromagnetic to generate the electromagnetic field necessary for the heating process (meaning a magnet has to stick to the bottom of the pan/coffee pot).

Pans/coffee pots made from the following materials are not suitable:

- glass, wood, porcelain, ceramic, stoneware;
- pure stainless steel, aluminium or copper without magnetic bottom.

To check if a pan/coffee pot is suitable or not:

- Test the bottom of the pan/coffee pot with a magnet: if the magnet sticks, the pan is suitable.
- If a magnet is not available pour a small amount of water inside the pan/coffee pot and place the pan on a cooking zone. Switch on the cooking zone: if the cooking zone display shows alternately the set power level and , the pan/coffee pot is not suitable .

**Important: Do not use pots/coffee pot adaptors; this could cause an overheating and possible damage to the appliance.**

**Important note:** the cooking zones will not operate if the pan/coffee pot diameter is too small. To correctly use the cooking zones follow the indications given in the following table.

Induction cooking zone	Minimum pan diameter recommended (referred to the bottom of the pan)
Cooking zone 190 x 210 mm	110 mm
Cooking zones Bridged	230 mm
Cooking zone Ø 250 mm	130 mm

**IMPORTANT:** Some cookware available on the market has an effective ferromagnetic area which is much smaller than the diameter of the pan itself. Avoid using this cookware because the induction cooktop may not function properly or may be damaged.

**Pay attention:** The pan/coffee pot shall always be centred over the middle of the cooking zone. It is possible to use oversized pans/coffee pots but its bottom shall not touch the other cooking zone.

Always use pans/coffee pots with thick, completely flat bottom.

Do not use pans/coffee pots with concave or convex bottom; these could cause overheating of the cooking zone.

**Note:** Some types of pans/coffee pots could cause noise when used on an induction cooking zone.

The noise does not mean any failure on the appliance and does not influence the cooking operation.

**Always lift pans off the induction hob – do not slide, or they may scratch the glass.**



## HOW TO SWITCH ON/OFF THE COOKTOP

### Switching ON



Touch the key  until the touch control system is lit (fig. 2.1). The displays of the cooking zones read “” or “.” (depending if a pan is placed or not on the relative zone).

Fig. 2.1



### Notes:

- If the safety Child Lock Safety or Key Lock Safety is active, the cooktop can be used only after having deactivated this protection (see chapter CHILD LOCK SAFETY and KEY LOCK SAFETY).
- Auto switch-Off: If a cooking zone is not turned On within 20 seconds, the cooktop will automatically switch off.

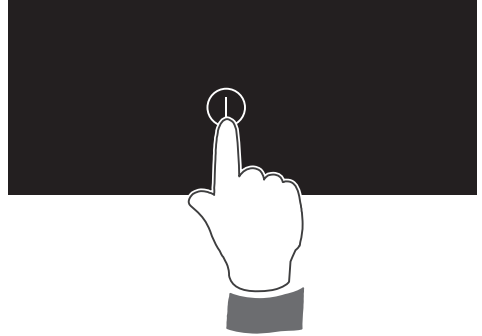
### Switching OFF

The cooktop may be switched Off at any time by pressing the key . If any cooking zones are turned On, they will be turned Off.

## POWER IGNITION AND ADJUSTMENT OF A COOKING ZONE

To turn On a cooking zone the cooktop must be switched On (see section “HOW TO SWITCH ON/OFF THE COOKTOP”).

Fig. 2.2



- Select a cooking zone by touching the relevant display of the cooking zone to be used (fig. 2.2).
- Select a setting on the selector [between “” (minimum) and “” (maximum)]: touch at one point to “jump” to a specific setting or slide your finger along the selector (fig. 2.3).
- The cooking zone display shows the selected level.
- The power level can be modified at any time.



Fig. 2.3



## GENTLEHEAT LOW SETTING (WARMING/MELTING)

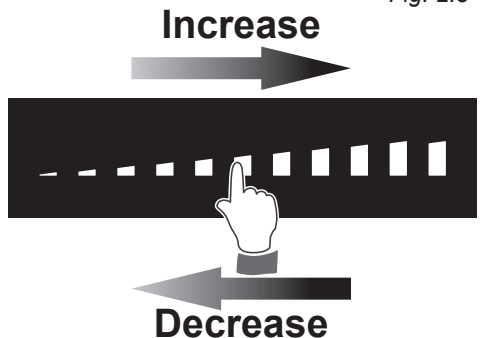

This function is ideal for the most delicate cooking tasks (such as melting chocolate), as the cooking zone will provide a very low continuous gentle heat. It is also ideal for keeping cooked food warm and the gentle warming of delicate foods.

To turn On a cooking zone the cooktop must be switched On (see section “HOW TO SWITCH ON/OFF THE COOKTOP”).

- Select a cooking zone by touching the relevant display of the cooking zone to be used.
- Touch the key .
- The cooking zone display shows .

## “FAST HEATING” FUNCTION

To activate the “Fast Heating” function:













- Press the key  and keep it pressed until the touch control is lighted.
- Select a cooking zone by touching the relevant display of the cooking zone to be used.
- Select a setting on the selector (between “1” and “8”): touch at one point to “jump” to a specific setting or slide your finger along the selector (fig. 2.3) and press for several seconds, the operation is indicated by an acoustic signal (beep). The cooking zone display alternates between set power level and .

This function allows the cooking zone to operate at the maximum power (100%) for a time proportional to the selected power level; after this time the cooking zone will operate at the selected level.

This function is available on all the cooking zones.

While this function is operating it is possible, at any time, to increase the selected power level but it is not possible to decrease the power; by touching the selector to a lower level the function will be disabled.



The function will be disabled also by press the key  or by selecting the “Booster” function.

Power level of Cooking zones	Operation time limit
	function not available
	15 seconds
	25 seconds
	50 seconds
	120 seconds
	170 seconds
	350 seconds
	170 seconds
	195 seconds
	function not available
	function not available
	function not available

## “FULL BRIDGE” FUNCTION (EXTENDABLE MAXI ZONE)

This function can be used to link the two zones (only for induction cooking zone 160 x 180 mm) in “Bridge” mode, to create an extended maxi zone which is ideal for large rectangular pans or specialist fish cookware.

To enable this function:

- Switch on the hob (see section “HOW TO SWITCH ON/OFF THE COOKTOP”).
- Select both of the two zones by finger pressure (fig. 2.4).
- Select the power level [from “1” (minimum) to “P” (maximum)]: touch the desired power level on the power selector or slide your finger over it (fig. 2.3).
- The front cooking zone display will show the heat setting. The rear cooking zone will show .
- The power level can be changed at any time by selecting front cooking zone (the dot indicator light of the front zone is lighted) and then setting the new level as described previously.
- To disable the “Bridge” function repeating the simultaneous selection of both cooking elements or switching off by key .

**Note: It is not possible to activate the Double Booster function.**

Fig. 2.4

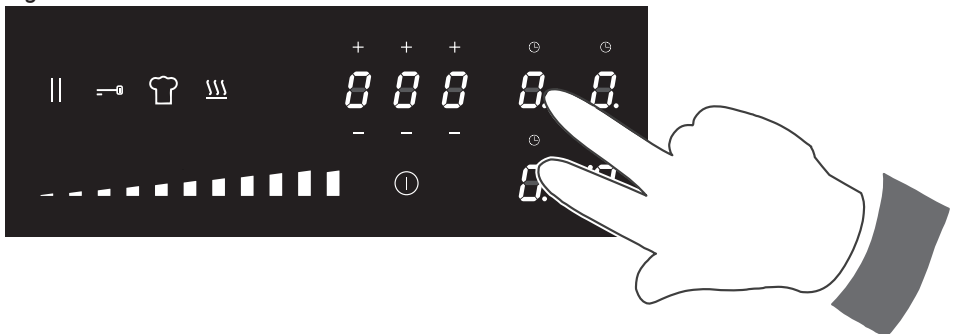

## BOOSTER FUNCTION

This function allows the cooking zone to operate at the “Booster” maximum power (above the nominal power) for maximum 5 minutes; it could be used, for example, to rapidly heat up large amount of water.

To activate the “Booster” function:

- The touch control must be switched ON (see section “How to Turn the Touch Control ON and OFF”).
- Select a cooking zone by touching the relevant display of the cooking zone to be used.
- Set the power level “P” for the selected cooking zone, as described in the section “POWER IGNITION AND ADJUSTMENT OF A COOKING ZONE”. The level “P” comes after level “9”.
- At the end of the Booster program (5 minutes) the cooking zone is automatically set to the power level “9”.

To deactivate the “Booster” function:

- Set a different power level on the selected cooking zone.  
or
- Switch Off the cooktop.

### IMPORTANT NOTES:

- The “Booster” function is not suitable for use with non water based cooking.
- Do not use this function for heating oil (e.g. deep fat frying).

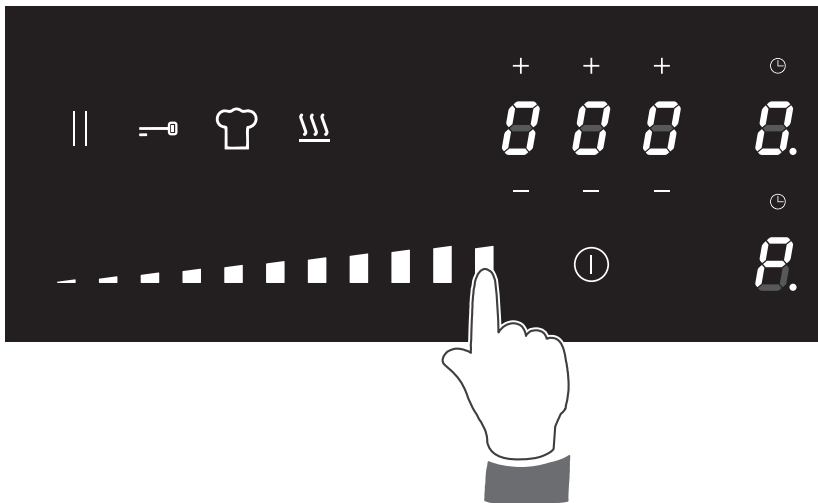

Fig. 2.5



## DOUBLE BOOSTER FUNCTION

The Double Booster function allows more power to be supplied compared to the Booster function.

To activate the “Double Booster” function:

Follow the same procedure as per booster function, then touch again the last level from the right on the setting selector (the display shows  and  alternating).

To deactivate the double “Booster” function:

- Set a different power level on the selected cooking zone.  
or
- Switch Off the cooktop.
- **This function is NOT available on the cooking zone Ø 250 mm and when the “Bridge” function is operating.**

### IMPORTANT NOTES:



- **The “Double Booster” function is not suitable for use with non water based cooking.**
- **Do not use this function for heating oil (e.g. deep fat frying).**

## “CHEF COOK” FUNCTION (if this function is not displayed, it means that it is not available because the hob is set at a too low maximum power level).

This function allows the zone to be ready to use at preset power levels for a maximum of 2 hours.

This means that, once selecting the “Chef Cook” function, each zone is ready in standby and as soon as placing a suitable pan on it, it is possible to start cooking (pan detection symbol is not active).

The preset power levels can be modified at any time (following the same procedure for the power adjustment of a cooking zone) once the “Chef Cook” function is operating. They are automatically saved for the next use of this function. They are shown on the zone displays when starting the “Chef Cook” function.

- To activate the “Chef Cook” function press the key  (brightness of key becomes higher).
- To deactivate the “Chef Cook” function press again the key .

## PAUSE MODE

When at least one cooking zone is in operation, the cooking may be paused temporarily by touching the key  (fig. 2.6).

Already programmed automatic cookings are stopped and do not continue during the pause.

The residual heat calculation and operating time limitation continue and are not stopped. The pause mode may last for max 10 minutes. If the pause mode is not terminated within the time, the cooktop switches Off automatically.

To deactivate the pause mode touch again the key  and then touch any cooking zone display.

The cooktop may be switched Off at any time with the On/Off key; any possibly program already set (pause mode included) is then terminated.

Fig. 2.6

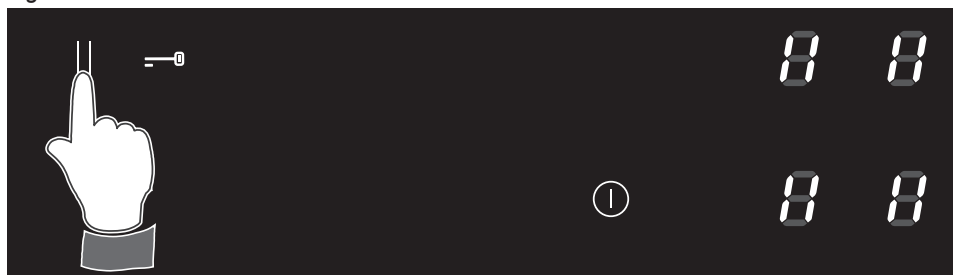

## CHILD LOCK SAFETY

When not using the induction hob, set the Child Lock safety to prevent children from accidentally switching On the cooking zones.

- Ensure all cooking zones are switched Off.
- Touch the key  until the touch control system is lit.
- Touch any cooking zone for 3 seconds. The slider area shows a chaser light sequence.
- Slide your finger along the selector from “1” (minimum) to “9” (maximum) within 10 seconds (before starting to slide, keep the finger in position “1” for about one second). “L” lights up.
- To deactivate the Child Lock, touch any cooking zone for three seconds and slide your finger along the selector from “9” (maximum) to “1” (minimum) within 10 seconds (before starting to slide, keep the finger in position “9” for about one second) until “0” or “.” lights up on the displays of the cooking zones.

## KEY LOCK SAFETY

This function locks the touch-control keys against unwanted activation e.g. while cleaning. To activate the key-lock press the key ; the brightness becomes high to indicate that the safety key-lock is active.

- Cooking zone/s operating (power level already set): with the key-lock protection active it is only possible to switch off the cooktop.
- Cooktop off: with the key-lock protection active it is not possible to use the cooktop. To use the cooktop deactivate this protection.

To deactivate the key-lock protection just press the key .

## OPERATION TIME LIMIT OF THE COOKING ZONES

Each cooking zone is automatically switched Off after a maximum preset time if no operation is performed.

The maximum preset time limit depends on the set power level, as illustrated in this schedule.

Each operation on the cooking hob by using the touch controls will reset the maximum operation time at its initial value.

POWER LEVEL OF COOKING ZONES	OPERATION TIME LIMIT
0	120 minutes
1	360 minutes
2	360 minutes
3	300 minutes
4	300 minutes
5	240 minutes
6	90 minutes
7	90 minutes
8	90 minutes
9	90 minutes
P	5 minutes
P and 01	5 minutes

COOKING ZONE POWER LEVEL	COOKING ZONE Ø 250 mm (Watt power)	COOKING ZONE 160 x 180 mm (Watt power)
<b>1</b>	75	60
<b>2</b>	120	105
<b>3</b>	180	165
<b>4</b>	270	255
<b>5</b>	420	375
<b>6</b>	645	585
<b>7</b>	960	885
<b>8</b>	1470	1320
<b>9</b>	2295	2100
<b>P</b>	3000	2300
<b>P</b> and <b>00</b>	not available	3000

### EXAMPLES OF COOKING POWER SETTING

<b>0</b>	Cooking zone not operating	
<b>1 to 2</b>	Melting Reheating	Sauces, butter, chocolate, gelatine Dishes prepared beforehand
<b>2 to 3</b>	Simmering Defrosting	Rice, pudding, sugar syrup Dried vegetables, fish, frozen products
<b>3 to 4</b>	Steam	Vegetables, fish, meat
<b>4 to 5</b>	Water	Steamed potatoes, soups, pasta, fresh vegetables
<b>6 to 7</b>	Medium cooking Simmering	Meat, lever, eggs, sausages Goulash, roulade, tripe
<b>7 to 8</b>	Cooking	Potatoes, fritters, wafers
<b>9</b>	Frying, roasting Boiling water	Steaks, omelettes, fried dishes Water
<b>P</b>	Rapidly heat up large amount of water	
<b>P</b> and <b>!!!</b>	Rapidly heat up large amount of water at the maximum power	



## PROGRAM FOR AUTOMATIC SWITCHING OFF OF A COOKING ZONE

This function permits to set a timer from “1” minute to “9” hours and “59” minutes for automatic turning Off the cooking zone/s.

With the cooktop switched On:

- Select the cooking zone and set the desired power level.
- Touch the timer key  (the timer key and the display of cooking timer starts blinking).
- Within 10 seconds set the timer using the + and - buttons to select the required time (the first digit on the left is used to select the hours, the middle one to set the tens of minutes and the one on the right the minutes).
- The program is now processed (the timer key indicating the programmed zone steady lit).
- The time can be changed at any time following the same procedure here above indicated.
- To program another cooking zone, repeat as described above.

Now the program for automatic switching Off is complete.

At the end of the countdown the cooking zone will switch Off automatically, an acoustic signal (beep) will sound (for 2 minute only), and “0.00” will flash on the timer display.

Touch one of the keys to stop the beep.

The program for automatic switch Off can be cancelled at any time by touching the timer key  for 3 seconds.

**IMPORTANT:** Remember to switch Off the zone manually.

Fig. 2.7

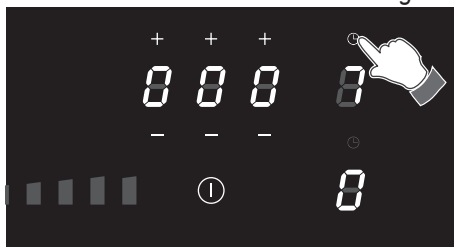
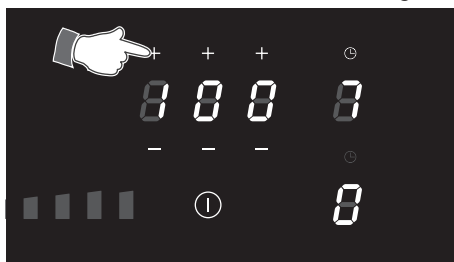

Fig. 2.8



## MINUTE COUNTER

The minute counter is a timed acoustic warning device which can be set from “1” minute to “9” hours and “59” minutes.

With the cooktop switched On:

- Touch the timer display (the display starts blinking).
- Within 10 seconds set the timer using the + and - keys to select the required time (first digit from the left = hours, second and third digit from the left = minutes, each single digit can be adjusted individually).

At the end of the countdown, an acoustic signal (beep) will sound (for 2 minute only), and “0.00” will flash on the timer display. Touch one of the keys to stop the beep.

IMPORTANT: Remember to switch Off the zones manually.

Fig. 2.9

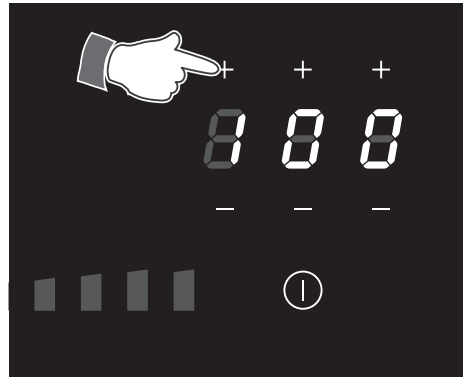

## COUNT UP

This function starts an incremental count and it can be activated for each single zone when it is in operation.

It can be used e.g. to control how long the cooking has been in progress.

With the cooktop switched On:

- Select the cooking zone and set the desired power level.
- Touch the timer key (⏸) (above the relative zone) for 3 seconds (an acoustic signal, beep, will sound).
- The count up is visible for the first 10 seconds, then it is hidden. To show it again, for 10 seconds, touch the cooking zone display.

The count up can be cancelled at any time by touching the timer key (⏸) for 3 seconds (the display reads “0.00”).

## RECALL FUNCTION

This function can be used when the cooktop is switched Off unintentionally during the use (e.g. by touching the key (⏸)).

In this case, by switching On the cooktop again within 6 seconds and by touching immediately the key (⏸), it is possible to restart the the cooking with all the previous settings before the switching Off.

## MAXIMUM USABLE POWER FOR THE COOKING ZONES

The cooking zones are controlled by 3 separate power boards:

The maximum total power per each power board is 3700 W.

Should the cooking zones of one power board require more than 3700 W, the last selected power level has priority and the power of the other cooking zone is automatically reduced to the remaining power available.

If this occurs, the cooking zone will display a flashing figure for about 3 seconds before automatically displaying the new power level.

This means for example that:

- When setting a “Booster” programme for the second zone, the setting for the other zone could be reduced to the remaining power available.
- When setting a “Booster” programme for a zone and then another setting on the second zone, if the total power exceed 3700 W the “Booster” programme is deleted and the power reduced to the maximum power available.

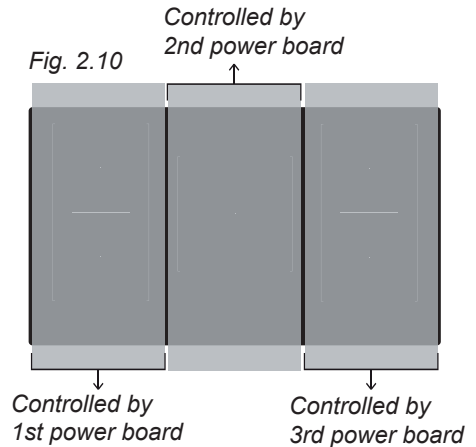

## THERMAL PROTECTIONS

The induction hob is fitted with safety devices to protect the electronic system and to protect each cooking zone from overheating.





In case of overheating, one of the following automatic functions could be started by the electronic system:

- “Booster” program deleted and power reduced.
- One or more cooking zone switched Off.
- Cooling fan motor of the induction unit switched On.

## USER MENU

With the user menu it is possible to customize some features as described in table 9.1.

To access the User Menu:

- Switch On the cooktop by touching the key ①.
- Touch the key again ① and keep it pressed until the symbol  starts blinking.
- Touch the key  and keeping it pressed touch, one at a time, the selecting zone keys (showing ) starting from the front-left zone key and then proceeding in clockwise order until touching all the zone keys.
- In the rear selection zone key each menu option is indicated, on the display, with the letter “U” alternating with a number (see table 9.1). The setting of each option is indicated in the front selection zone key or in the timer display.
  - To change the menu option, touch the rear selection zone key (where “U” alternates with a number) and then use the setting selector to choose another option (each selector bar is assigned to an option).
  - To change the setting of each option, touch the front zone selection key (or the timer display for the maximum power management “” only) and then modify the setting by using the setting selector (depending on the option being customized, only some bars may be operative).
- Once completing the customization, switch Off the cooktop by touching the key ①.

Menu Option	Description	Remark
U0	Maximum power management	To change the setting, use the setting selector by touching the left bar to decrease or the right bar to increase (see also chapter MAXIMUM POWER MANAGEMENT following).
U1	This option is not available in your model.	
U2	Beeps volume (when touching a selection key)	Adjustment settings: 0: no beeps 1: min. volume 2: mid. volume 3: max. volume  Notes: <ul style="list-style-type: none"> <li>• For safety reasons, the Beeps when switching On and Off cannot be disabled.</li> <li>• Beeps for errors are always at max. volume and cannot be disabled.</li> </ul>
U3	Acoustic signal volume (e.g. after a programmed cooking)	Adjustment settings as per <b>U2</b> .
U4	Display brightness	Adjustment settings: 0: Max. brightness .... 9: Min. brightness
U5	Timer digits animation (segments of the numbers fully displayed or displayed progressively)	Adjustment settings: 0: No animation 1: Animation
U6	Automatic pot detection (shows if there is a pot or not on a cooking zone)	Adjustment settings: 0: Pot detection not active 1: Pot detection active
U7	Duration of acoustic signal (e.g. after a programmed cooking)	Adjustment settings: 0: 120 secs 1: 10 secs 2: No signal

## MAXIMUM POWER MANAGEMENT

Depending on the specific market requirements, the product is supplied with a maximum power (factory setting) as indicated on the rating label (see possible options in table below). The maximum power can be modified in any time (100W steps) by accessing the User Menu, option “**UD**” (see chapter USER MENU).

### IMPORTANT:

- It is only possible to decrease (NOT increase) the power with respect to the maximum factory setting.
- If the cooktop is already set in factory to the minimum power level, it is not possible to carry out any modification.
- The maximum power setting can be checked in any time by accessing the User Menu, option “**UD**” (see chapter USER MENU).

For the models factory-set at the maximum higher power (last column of the table here below), the display doesn't show the total power of the cooktop but the total power for each power board.

Models	1,4 kW	2 kW	2,5 kW	2,8 kW	3 kW	3,5 kW	4 kW	5 kW	6 kW	Maximum higher power (kW) referred to each power board
90cm wide	✓	✓	✓	✓	✓	✓	✓	✓	✓	3,7 x 3 power boards

## POWER MANAGEMENT WHEN USING THE COOKTOP

Should the cooking zones of one power board require more than the maximum total power, the last selected power level has priority and the power of the other cooking zone is automatically reduced to the remaining power available (or switched off if there is not enough power available).

If this occurs, the cooking zone will display a flashing figure for about 3 seconds before automatically displaying the new power level.

## ERROR CODES ON THE DISPLAYS OF THE COOKING ZONES

Error code	What to do
<b>Erxx</b>  <b>or</b>  <b>display not operative</b>	<ol style="list-style-type: none"><li>1. Switch Off the cooktop and disconnect it from the mains.</li><li>2. Wait for about 1 minute, then reconnect the cooktop and turn on the cooking zones.</li><li>3. Wait for about 1 minute and if the error message does not appear again the cooking zones can be used.</li><li>4. If the error message does not disappear repeat step from 1 to 3.</li><li>5. If the problem continues do not use the induction hob and contact your Authorised Service Centre.</li></ol>
<b>Er03</b>	<ol style="list-style-type: none"><li>1. Permanent activation of the controls area. e.g. an object positioned on the touch controls or a liquids spillage on the controls area.</li><li>2. Please remove the object or dry the liquids.</li></ol>

## SAFETY HINTS

- Before switching on make sure that you have the correct cooking zone for the hotplate chosen. It is advisable to put the pan on the hotplate before switching on and to take it away after switching off.
- Use correct cookware suitable for induction cooking (normally identified by an induction symbol on the bottom). The use of not suitable cookware may cause damage to the appliance.
- Use cookware with flat and even bottoms. Uneven bottoms can scratch the glass ceramic surfaces. Be careful that the bottom is clean and dry.
- To save electricity, use pan lids whenever possible.
- Do not leave wet or damp lids on the hob.
- Make sure that the handles of cookware do not stick out over the edge of the hob, to avoid them being knocked over by accident. This also makes it more difficult for children to reach the cooking vessels.
- Do not put aluminium foil or plastic objects on the cooking zones when they are hot.
- Do not lean over the cooking zones when they are switched on.
- The glass-ceramic surface and pans must be clean. Carefully eliminate any food remains (especially containing sugar), dirt etc. with the aid of a cleansing agent.
- Follow the cleaning instructions carefully.
- **Do not use the hob if the glass surface is broken or cracked in any way. Please disconnect the hob from the mains and contact the After-Sales Service.**
- Never use the glass surface for storage.

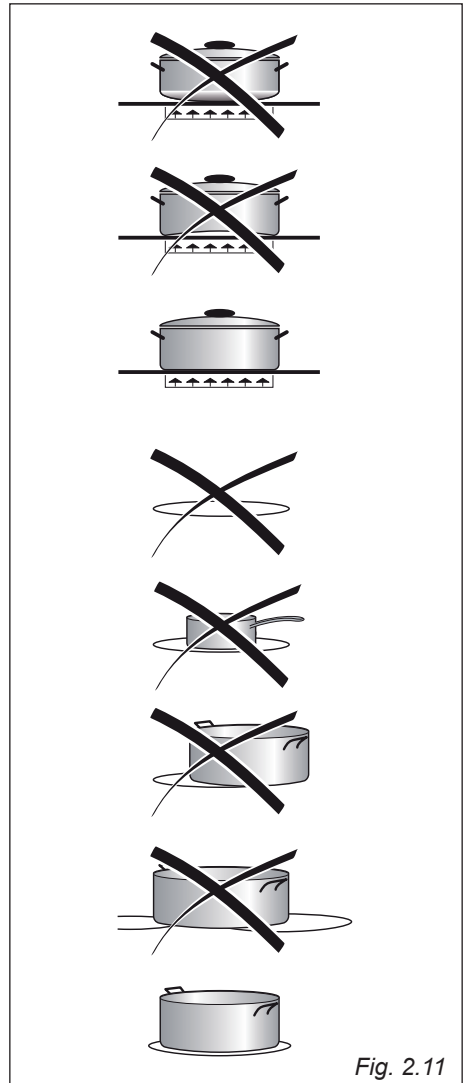

Fig. 2.11

**DO NOT USE PANS WITH ROUGH CIRCULAR MACHINED BASE.**



Fig. 2.12



# 3

## CLEANING AND MAINTENANCE

### GENERAL ADVICE

- **Before you begin cleaning, you must ensure that the appliance is switched off and disconnected from the electrical power supply.**
- It is advisable to clean when the appliance is cold.
- Avoid leaving alkaline or acidic substances (lemon juice, vinegar, etc.) on the surfaces.
- Avoid using cleaning products with a chlorine or acidic base.
- **Do not use a steam cleaner because the moisture can get into the appliance thus make it unsafe.**
- **Important: The use of suitable protective clothing/gloves is recommended when handling or cleaning of this appliance.**
- **Do not scratch the cooktop with cutting or sharp objects.**
- **Important: The manufacturer declines all liability for possible damage caused by the use of unsuitable products to clean the appliance.**
- Clean surfaces with a damp cloth and use gentle, neutral cleaning products. Dry with a clean, dry cloth.
- **IMPORTANT:** Do not use any abrasive products (e.g. certain types of sponge) and/or aggressive products (e.g. caustic soda, products containing corrosive substances), which could cause irreparable surface damage.

### WARNING!

**When correctly installed, your product meets all safety requirements laid down for this type of product category. However special care should be taken around the underneath of the appliance as this area is not designed or intended to be touched and may contain sharp or rough edges, that may cause injury.**

## CLEANING THE CERAMIC HOB

- Remove spillages and other types of incrustations.
- Dust or food particles can be removed with a damp cloth.
- If you use a detergent, please make sure that it is not abrasive or scouring. Abrasive or scouring powders can damage the glass surface of the hob.
- All traces of the cleaner must be removed with a damp cloth.
- Dust, fat and liquids from food that has boiled over must be removed as soon as possible. If they are allowed to harden they become increasingly difficult to remove. This is especially true in the case of sugar/syrup mixtures which could permanently pit the surface of the hob if left to burn on it.
- Do not put articles on the hob which can melt: i.e plastic, aluminium foil, sugar, sugar syrup mixtures etc.
- If any of these products has melted on the ceramic surface, you should remove it immediately (when the surface is still hot) by using a proper scraper to avoid any permanent damage to the surface of the hob.
- Avoid using a knife or other sharp utensil as these may damage the ceramic surface.
- Do not use steel wool or an abrasive sponge which could scratch the surface permanently.

## STAINLESS STEEL ELEMENTS (only models with side stainless steel trims)

Stainless steel parts must be rinsed with water and dried with a soft and clean cloth.

For persistent dirt, use specific non-abrasive products available commercially or a little hot vinegar.



# SERVICE AND MAINTENANCE

## **Servicing the appliance:**

Service may be obtained by contacting our Customer Service Centre to locate the nearest Authorised ELBA APPLIANCES Service Agent shared services with Fisher and Paykel Australia PTY LTD (ELBA Appliances AUS, a division of F&P AUS PTY LTD):

**Servicing shall be carried out only by authorized personnel.**

**The appliance shall not be modified.**

## **TROUBLESHOOTING**

If you acquire a problem with your hob, check the following points before calling an engineer.

1. The power is switched on.
2. The controls are switched on.
3. Both the fuse and the mains fuse are intact.

Should you still require assistance please contact our Customer Service Centre for your nearest Authorised Elba Appl. AUS Service Agent..

Descriptions and illustrations in this booklet are given as simply indicative.  
The manufacturer reserves the right, considering the characteristics of the models described here, at any time and without notice, to make eventual necessary modifications for their construction or for commercial needs.

---

[www.delonghicookingappliances.com.au](http://www.delonghicookingappliances.com.au)

